



INSTALLATION INSTRUCTIONS

UNIVERSAL FUEL SURGE TANK, INTERNAL PUMP MODELS

SUPPORT: info@radiumauto.com

DOCUMENT: 19-0040

WARNING: DO NOT EXPOSE WORK AREA TO ANY SPARKS OR FIRE. DO NOT SMOKE WHILE OPERATING ON THE FUEL SYSTEM. CLEAN UP ALL FUEL SPILLS IMMEDIATELY. WORK IN A WELL VENTILATED AREA.

READ AND UNDERSTAND THESE INSTRUCTIONS COMPLETELY BEFORE BEGINNING INSTALLATION

The Radium Engineering Fuel Surge Tank (FST) is designed to enhance the fuel system by providing resistance to starvation (from fuel slosh) and by increasing the fueling capability of the system. It is designed for fuel injected engines only and should not be used in carbureted applications.

The primary fuel pump in the vehicle's main fuel tank will no longer directly feed the engine. This pump will now be used to fill and maintain the level of fuel in the surge tank. The FST pump will now be the high pressure source for the engine's fuel demand. This fuel must be pressure regulated either with a factory fuel pressure regulator (if equipped), or an aftermarket regulator. Fuel pressure should be checked before and after installation to ensure that there is no difference with the FST operating. Any change in fuel pressure can affect engine performance.

Note: It is normal to find a small amount of test fluid inside the FST if pumps were preinstalled by Radium Engineering. These units are tested and ready for installation.

MOUNTING

The FST should be firmly mounted to a stable, structural component of the vehicle away from moving parts, excessive heat, and collision areas. The FST should not shake or vibrate during operation. Excluding the Ti Automotive E5LM FST models, all others can be mounted from 0° (horizontal) up to 90° (vertical). NEVER ORIENT THE FST WITH FITTING END DOWNWARD which can lead to premature fuel starvation.

When mounting horizontally, make sure the fuel pump inlet port(s) are at the lowest point possible. For Bosch 044 FST model, there is an arrow on the bottom side of the FST illustrating the proper orientation required.

For maximum starvation protection, the single and dual pump Ti Automotive E5LM FSTs should be mounted as close to vertical as possible. Unlike others, these fuel pump inlets are offset effectively centralizing the pickups in the bottom of the FST.

Two sets of four M6x1.0mm mounting bosses are machined on the side of the canister and bottom cap of the aluminum FST. Use a medium strength thread locker, on the M6x1.0mm fasteners that thread into the FST. Optional mounting brackets and hardware are available from Radium Engineering. See the dimensions pictured if a custom mounting bracket solution is to be made.

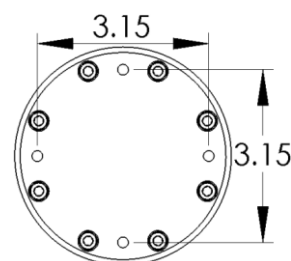
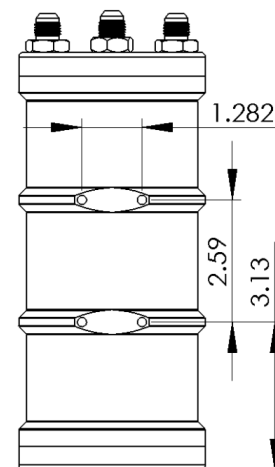
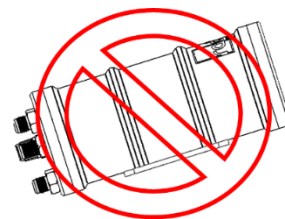

SINGLE PUMP FST PLUMBING

There are many ways to plumb a FST. This document will outline the most common methods. There are four -6AN fittings on the FST. The green fitting is the internal pump's high-pressure outlet that will feed the engine's fuel rail(s). When the FST is mounted, the port that is at the highest fluid level should be plumbed to the main fuel tank. This ensures that any air trapped in the FST escapes back to fuel tank. The other 2 ports from the "lift" pump and from the FPR return are interchangeable and are not critical.

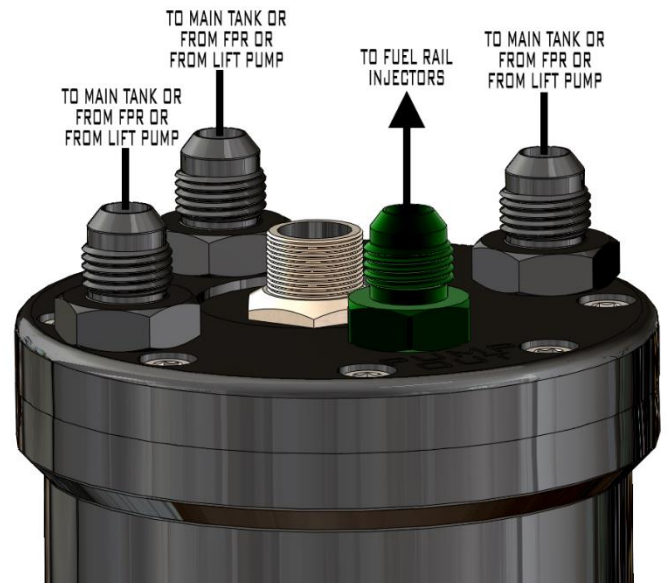

NOTE: The architecture of the Bosch 044 FST does not permit the use of a sock filter on the fuel pump inlet. An external filter must be installed upstream of the FST.

Option 1: Traditional Return Fuel System

If the engine is equipped with a fuel pressure regulator on the fuel rail, this diagram illustrated below can be used.

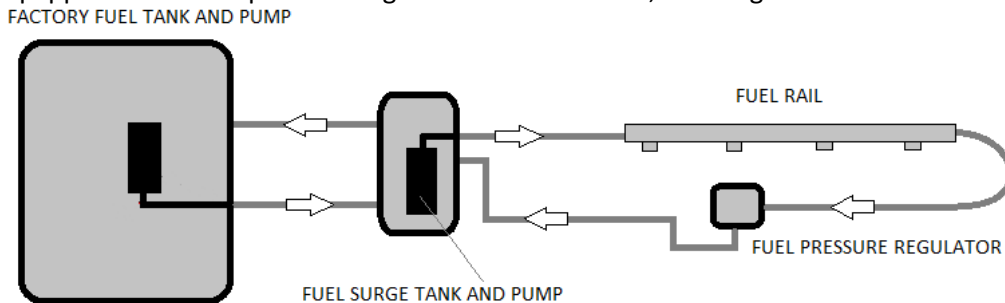

Option 2: Dead-End Fuel System

This is suited for engines that have no return line from the fuel rail. This system keeps fuel temperatures down.

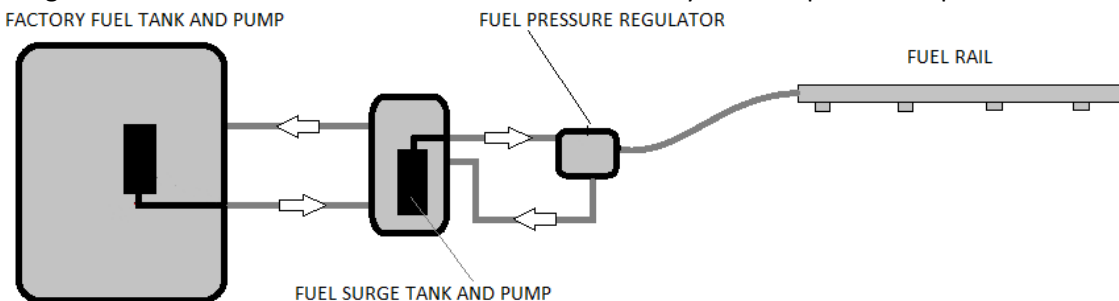

Option 3: Dead-End Fuel System

The diagram below can also be used for vehicles that have no return line from the injector fuel. However, this setup is better suited for high powered applications that demand lots of fuel flow by preventing any restriction that the fuel pressure regulator may present. This system also keeps fuel rail inlet temperatures down.

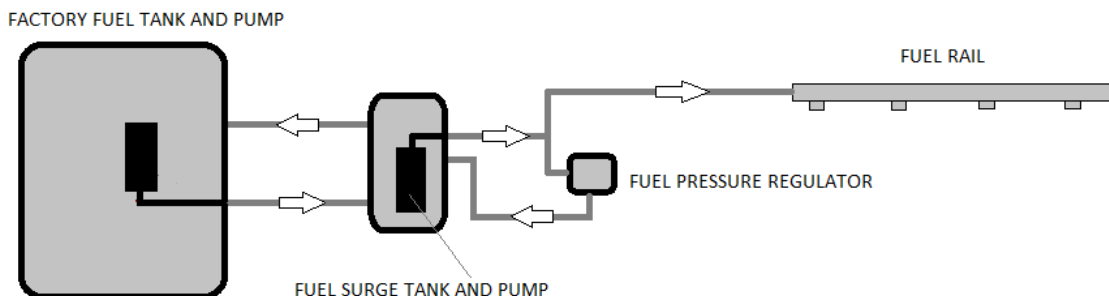

SINGLE PUMP FST WIRING (excluding 20-0211 Brushless FST)

If the fully populated harness was purchased, reference the instruction manual included for wiring information.

The surge tank pump must be wired to a 12V source capable of providing 20 amps. The standard 24" flying lead wiring harness is color coded for easy identification (red is power, black is ground). A 20 amp fuse should be used along with at least 12 AWG wire for both contacts (10 AWG for long runs). It is highly recommended to activate the FST pump with a relay which is triggered by the same signal as the primary fuel pump.

The top right diagram assumes that the primary fuel pump signal is positive 12V. This should be verified with a multi-meter. If the signal is a ground, the relay should be wired as shown in the diagram bottom right.

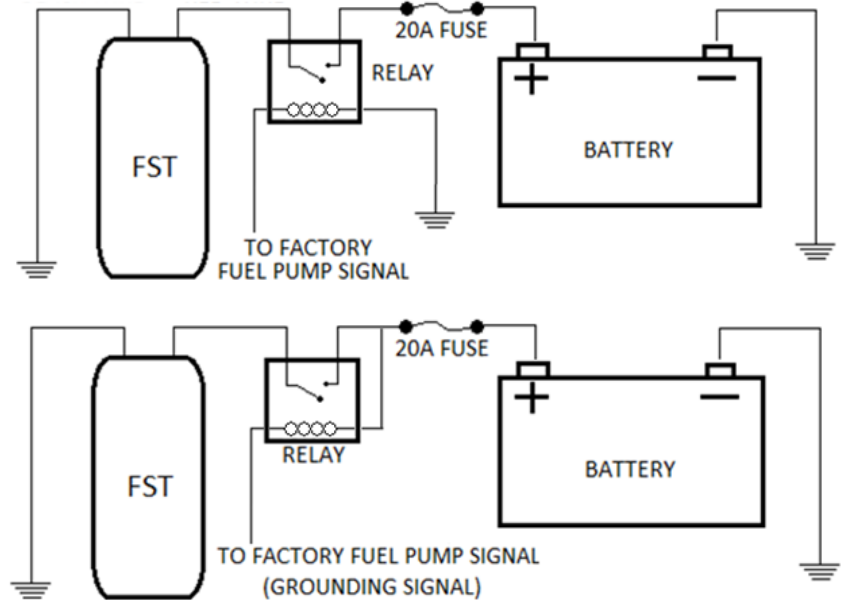

DUAL PUMP FST PLUMBING

There are many ways to plumb a dual pump FST. This document will outline the most common method. **FUEL ENTERING THE FST FROM THE "LIFT" PUMP MUST BE FILTERED.** There are five -6AN fittings on the FST. The green fittings are the internal pumps' high-pressure outlets that will feed the engine's fuel rail(s). When the FST is mounted, the port that is at the highest fluid level should be plumbed to the main fuel tank. This ensures that any air trapped in the FST escapes back to fuel tank. The other 2 ports from the "lift" pump and from the FPR return are interchangeable and are not critical.

NOTE: it is normal for the fuel pump sock filters to overlap each other when the FST is assembled.

The fuel system illustrated below shows an example of a common plumbing schematic for dual pump system on a V or H engine with two fuel rails. However, there are many other possible configurations that are not covered in this document.

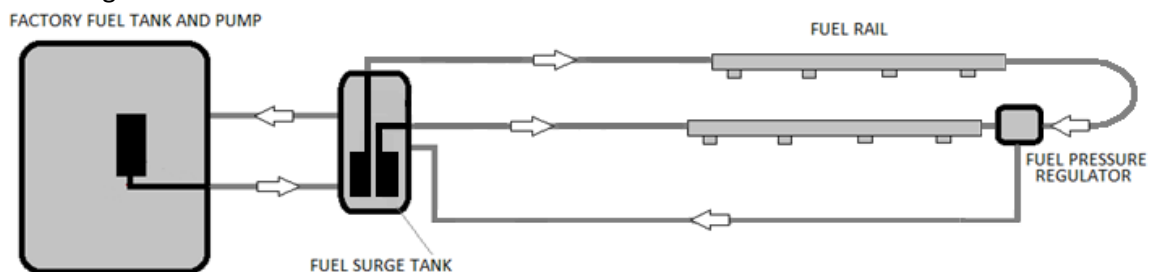
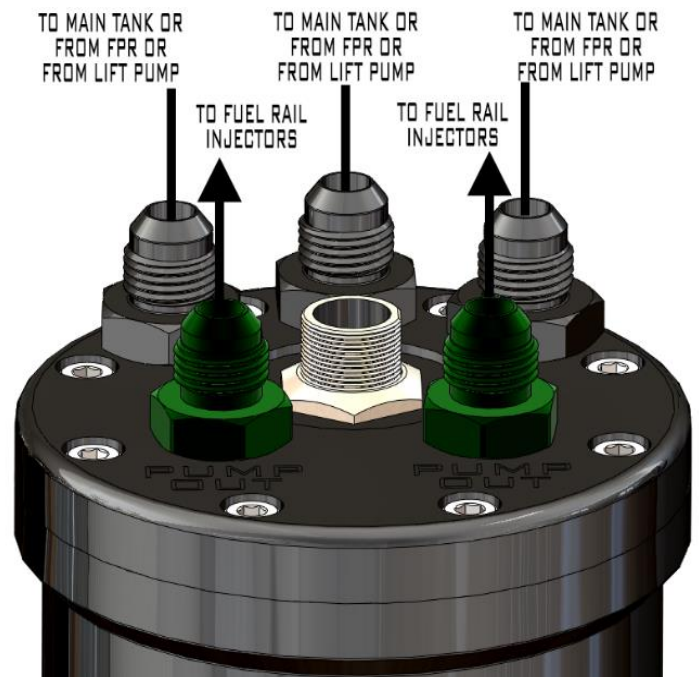

DUAL PUMP FST WIRING (excluding 20-0212 Brushless FST)

The flying lead harness wires are color coded for easy identification and described below.

PIN1:	FUEL PUMP1	12V POWER	RED WIRE
PIN2:	FUEL PUMP2	12V POWER	ORANGE WIRE
PIN3:	FUEL PUMP2	GROUND	GRAY WIRE
PIN4:	FUEL PUMP1	GROUND	BLACK WIRE

The surge tank pump(s) shall be wired to a 12VDC power source using 20amp fuses and 12AWG wire (10AWG for long runs).

The top right diagram illustrates the FST pumps activating from the same signal as the primary lift pump. The bottom right diagram illustrates 1 FST pump triggering from the lift pump signal and the other FST pump activating via a programmable EMS output signal.

Both diagrams assume the fuel pump triggers are 12V. Check with a multi-meter as they are commonly ground triggers.

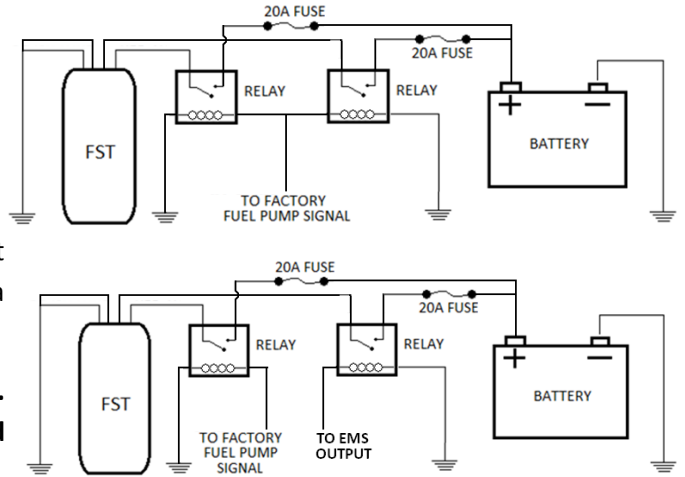

TI Automotive E5LM and DW400 9-401 Pumps Only

1. Using electrical dikes, cut all wires found on the fuel pump manufacturer's flying lead wiring connector(s) to 5 inches, as shown.

Next, strip the insulation back on all wires ~3/16" (5mm) from the fuel pump manufacturer and Radium Engineering internal connectors.

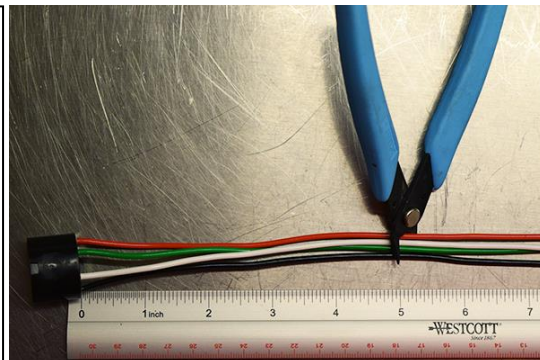

2. For each connection, insert a wire through one side of a crimpless butt connector (included). Using the "Wire Color Cross Reference" charts below, find the opposing wire and twist the 2 together. Next, center the butt connector on the bare wires. Using a heat gun, circle around the connector to melt the solder and heat shrink consistently, as shown. Be careful with the surrounding area as the internal solder can take awhile to melt. Finally, verify the connection is solid by gently tugging.

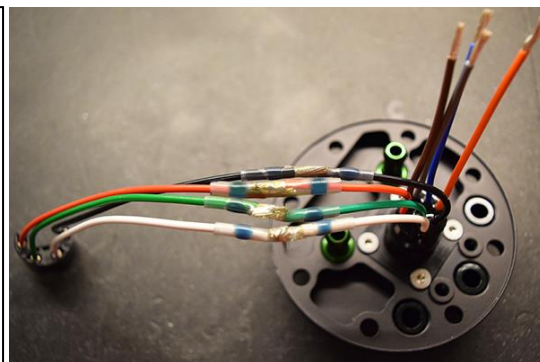

20-0257 SINGLE DW400 9-401 PUMP FST

Use the chart to connect the Radium Engineering bulkhead wires to the pump and to the external flying lead wire harness.

NOTE: Unlike the 4-wire brushless fuel pumps, this DW400 9-401 fuel pump has just 2 wires. Internally connect as follows: DW400 BLUE power wire to Radium RED and GREEN wires. DW400 BLACK ground wire to Radium WHITE and BLACK wires.

WIRE COLOR CROSS REFERENCE SINGLE PUMP FUEL SURGE TANK

DW400 9-401	RADIUM Internal	RADIUM External
BLUE->	<-RED <-GREEN	RED
BLACK->	<-WHITE <-BLACK	BLACK

20-0211 SINGLE BRUSHLESS PUMP FST

Use the chart to connect the Radium Engineering bulkhead wires to the pump and to the external fuel pump controller.

WIRE COLOR CROSS REFERENCE SINGLE PUMP FUEL SURGE TANK

TI Automotive	RADIUM Internal	RADIUM External
RED->	<-RED	RED
GREEN->	<-GREEN	ORANGE
WHITE->	<-WHITE	GRAY
BLACK->	<-BLACK	BLACK

20-0212 DUAL BRUSHLESS PUMP FST Use the chart to connect the Radium Engineering bulkhead wires to the pumps and to the external fuel pump controllers. NOTES: 1. If these fuel pumps will be staged, it is important to coordinate the pumps' electrical wiring to the proper pump outlet fitting using the "Pump1" and "Pump2" machined labels in the top cap with the wire colors in the chart. 2. This dual E5LM pump FST variation must be kept under 15 amps of current for each Ti Automotive pump.

WIRE COLOR CROSS REFERENCE DUAL PUMP FUEL SURGE TANK

TI Automotive	RADIUM Internal	RADIUM External
PUMP-1, RED->	<-RED	RED
PUMP-1, GREEN->	<-GREEN	GREEN
PUMP-1, WHITE->	<-WHITE	WHITE
PUMP-1, BLACK->	<-BLACK	BLACK
PUMP-2, RED->	<-ORANGE	ORANGE
PUMP-2, GREEN->	<-BLUE	BLUE
PUMP-2, WHITE->	<-GRAY	GRAY
PUMP-2, BLACK->	<-BROWN	BROWN

Service and Assembly

Servicing (excluding 20-0090 Single Bosch 044 FST)

1. Remove the eight M5 bolts on the top cap using a 4mm Allen.
2. Separate top cap assembly from canister. Do not lose the large gasket.
3. Unplug fuel pump(s) and unclip small hose clamp(s), if already equipped.
4. A. For single pump FSTs, remove large worm drive clamps around body of pump.
B. For dual pump FSTs, remove the large green aluminum fuel pump cradle.
5. Remove and replace fuel pump(s), if applicable.
6. Install the hose(s) onto the pump outlet barb(s) using oil lubrication.
7. Rotate pump(s) so the inlet(s) will be at the lowest point when installing FST.
8. Secure large clamps (or pump cradle for dual FST) and tighten outlet clamps.
9. Connect the fuel pump(s) to the electrical bulkhead connector(s).
10. For proper sock filters, install Radium 14-0143 (excluding brushless pumps)
11. One by one, insert the eight M5 bolts into the top assembly and hold in place with a 4mm Allen wrench.
12. From underside, push gasket over each bolt thread to hold it into place.
13. Carefully place the fuel pump assembly onto the canister.
14. Tighten M5 bolts in a cross-pattern making sure the gasket does not pinch.

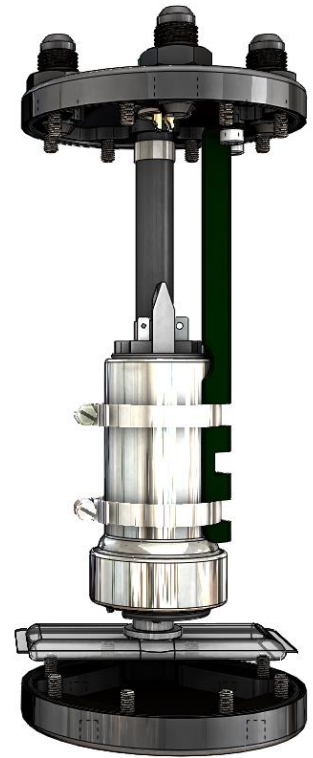

Servicing 20-0090 Single Bosch 044 FST

1. Remove the bulkhead nut on the green bulkhead -6AN male fitting.
2. Remove the electrical bulkhead nut using a 13/16" socket.
3. Remove the eight M5 bolts on the top cap using a 4mm Allen wrench.
4. Remove top cap and do not lose the electrical O-ring or gasket.
5. Remove the eight M5 bolts on the bottom cap.
6. Separate the bottom cap with fuel pump (if equipped) from the canister.
7. If installing a new pump, remove the OEM brass fitting from the outlet.
Note: An external filter must be used upstream from the Bosch 044 FST.
8. Using the included crush washer, tighten the green fitting to the outlet.
9. Using the included crush washer, tighten the bottom fitting to the inlet.
10. Using the included nuts, install the red wire ring terminal to the red color-coded M6 stud and the black wire to the blue color-coded M5 stud.
15. Flip the canister upside down. One by one, insert the eight M5 bolts into the bottom cap assembly and hold in place with a 4mm Allen wrench.
16. From underside, push gasket over each bolt thread to hold it into place.
17. Carefully place the fuel pump assembly onto the canister and screw in bolts.
18. Do not tighten the bottom 8 bolts until the top cap bolts have been installed.
19. Confirm there is a black Nylon sealing washer on the green bulkhead fitting.
20. Push electrical bulkhead through top cap and install nut and bolts, as above.
21. One by one, insert the eight M5 bolts into the bottom cap assembly.
22. Hold bolts in place with a 4mm Allen wrench.
23. From underside, push gasket over each bolt thread to hold it into place.
24. Carefully place the top cap onto the canister and screw in bolts.
25. Tighten all M5 bolts in a cross-pattern making sure the gaskets do not pinch.



INITIAL START UP

The surge tank must be fully primed with fuel before the engine will start. To do this, remove the FST pump fuse(s) and cycle the vehicle's ignition power several times. This will activate the primary fuel pump for a few seconds each time. After 3-4 cycles it should be ready to start. Replace the FST pump fuse(s).