

CAUTION

Only a qualified technician following applicable safety procedures should perform the installation of this product. One must have knowledge in repair and modification of fuel systems and general vehicle modifications to install this product.

Gasoline and other fuels are flammable and can be explosive.

Only install in a well-ventilated location to minimize buildup of fuel vapors.

No sparks, open flames, smoking or other ignition sources are to be present. Draining and removal of all fuel from the fuel system is recommended. Proper eye and personal protection is required at all times during installation.

WARNING

The fuel system is under pressure! Do not loosen any connections until relieving the fuel system pressure.

Consult a service manual for instructions on relieving fuel pressure safely. This product is designed for off-highway and racing use only.

Fuel system components may not be legal for sale or use on emissions controlled motor vehicles. Consult local, state, and federal laws.

1. It is recommended to drain the tank to reduce fuel spills for an easier and safer installation.

Open the trunk. Unclip and remove the trunk cover, carpet, and spare tire.

To uninstall the fuel tank access cover in the center of the trunk, remove the 6 perimeter nuts using a 10mm wrench.

Once removed, it is recommended to clean the top of the fuel pump housing and the surrounding area, as shown. This will prevent loose dirt from falling into the gas tank.



2. To depressurize the fuel system, first squeeze the tab and unplug the gray wiring connector on top of the pump housing (shown).

Start the engine and allow it to stall. Remove the key from the ignition. Unscrew the gas tank filler cap temporarily to relieve any residual pressure.

Pop the hood and disconnect the battery's negative terminal with a 10mm socket wrench.

CAUTION: Disconnecting the battery may cancel fault memories of some control units. Consequently, before disconnecting the car's battery, always interrogate any fault memories.



3. Disconnect the OEM banjo bolt fitting using a 17mm wrench. Using pliers, dislodge the OEM spring clamps and pull off the fuel return and vent hoses. Use a rag to clean any spilled fuel.

Loosen and remove the large worm drive jubilee clamp using a 10mm socket wrench.

The black fuel tank hold-down ring will need to be spun counterclockwise. Many technicians will use a hammer and flat chisel. However, it is recommended to purchase a spanner tool to avoid breaking this plastic threaded ring. These are relatively inexpensive and can be found online from companies such as Lisle, OEMTools, Ryco, etc. For the MK4 (JZA80) Toyota Supra, Radium Engineering successfully uses Lisle P/N: 63000 (shown).



4. Before removing the OEM unit, place an empty bucket nearby as there will be residual fuel in the gas tank. Slowly lift the assembly straight up.

NOTE: If this Supra gas tank came from a Twin Turbo (2JZ-GTE) model, it should have a rubber hose on the return line. Squeeze the spring clamp and pull the hose off the barb, as shown.

Next, gently squeeze the float arm inwards and tilt the assembly back and forth to clear the level sender and fuel pump sock filter. Pull the unit out and allow it to drain into the bucket. Clean the assembly and set it on a workbench.



5. As shown, there are 2 versions of the OEM Toyota Supra fuel pump assembly. The main difference is with the internal fuel return line.

The non turbo (2JZ-GE) Supra variation (top) uses a long hard pipe that routes to the bottom.

The Twin Turbo (2JZ-GTE) Supra (bottom) uses a short hard pipe. NOTE: This is the connection point where the internal rubber hose was disconnected in the previous step.

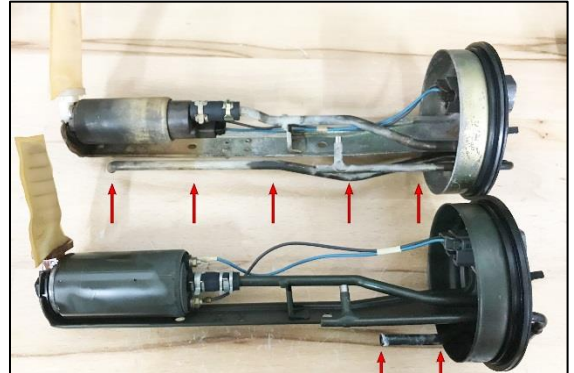

6. Only 2 parts will be reused from the OEM Toyota unit (gasket and sensors).

Pry and slide the large black gasket out and around the assembly.

As shown, there are 2 different types of fuel sensor assemblies. Both include a fuel level sender float and a temperature sensor probe. Both versions have a similar bracket that is compatible with the Radium fuel hanger.

Depress the thumb lock to unplug the 3-pin connector. To remove the bracket assembly, use a Phillips head screwdriver for the 2 small screws. These OEM screws will not be reused.

If the fuel pump hanger kit was purchased with fuel pump(s) included, skip Steps 7-19.

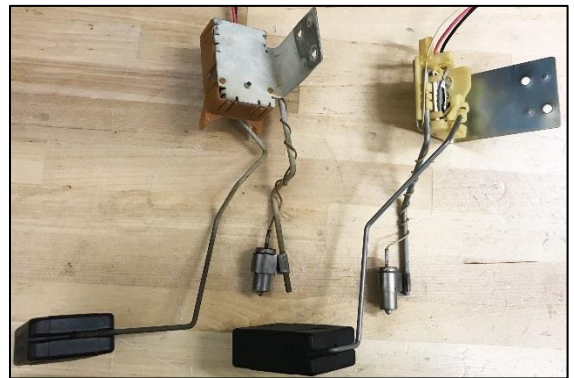

7. First, determine how many fuel pumps will be installed. As shown, attach the corresponding number of pump connectors to the wiring studs underneath the top hat using 3/8" wrenches. The red wires are positive (+) and black wires are negative (-).

Follow Steps 8-11 and 17-19 if installing any of the following into Radium 20-0412-00

- Walbro F90000274 Fuel Pump
- Walbro F90000267 Fuel Pump

Follow Steps 12-19 if installing any of the following into Radium 20-0410-00 and 20-0413-00

- Walbro GSS342 255LPH Fuel Pump
- AEM 50-1220 E85 Fuel Pump



8. **Radium 20-0412-00: Walbro F90000274 / F90000267 Fuel Pump Installation**

Before proceeding, inspect the pump outlet hose barb. If the hose barb is deformed, modified or damaged, the Radium Engineering fuel pump outlet adapter will not install correctly and the pump cannot be used.

Slide the black machined aluminum collar over the pump outlet with the flat surface upward. Slip the stainless-steel C-shaped retainer between the 2 large hose barbs. When assembled, the retainer will lodge itself under the barb ridge closest to the end of the pump outlet.

Place the included O-ring on the fuel pump outlet, as shown.



9. Apply a medium strength thread locking compound to the threads of the three included small screws. Slide the black collar upward and line up the green fitting holes to the black fitting threads. Secure and tighten all bolts evenly using a 2.5mm Allen wrench, as shown.

Perform this same procedure above for all fuel pumps that will be used.

Next, be sure there is an O-ring installed around the base of the 6AN male fitting (not shown in picture).

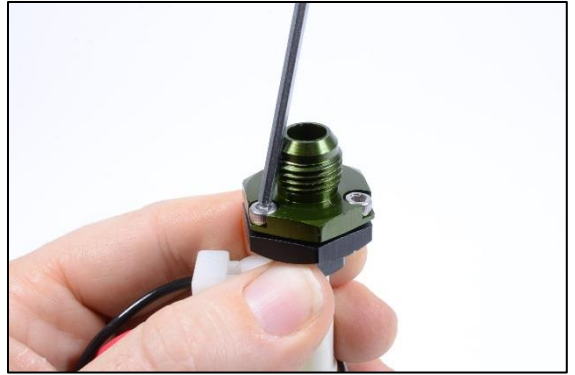

10. For single or dual fuel pump applications, block-off the unused ports on the underside of the triple pump block using the included 6AN ORB plug fittings. For clearance purposes, it is best to plug the hole nearest the fuel sensor mount (shown).

NOTE: Lubricate all O-rings with light oil before installing any ORB fittings.

Install the fuel pump outlet green fitting(s) into the underside of the triple pump block using a 15mm wrench. Any of the 3 ports can be used as they share the same external outlet. However, if installing three Walbro F90000274 (or 267) fuel pumps, the 2-bolt Radium sensor mount will need to be temporarily removed for the fuel pump fitting hex to clear when tightening.



11. Rotate the fuel pump(s) so the power wires are facing outwards. Next, lubricate the orange connector seal(s) and plug in the fuel pump connector(s), as shown.

Skip to Step 17.

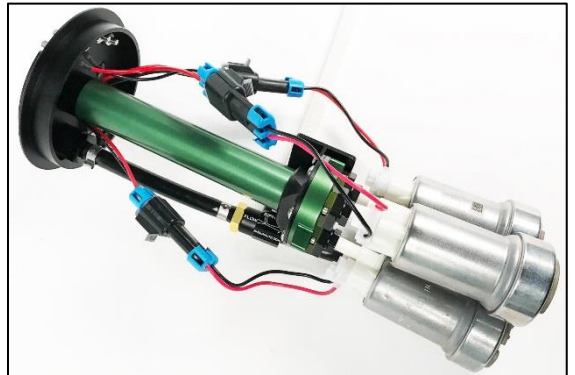

12. Radium 20-041(0 or 3)-00 Walbro GSS342 or AEM 50-1220 Fuel Pump Installation

If installing less than 3 pumps, unscrew the triple pump block from the long 10AN pipe by hand. Remove the 6 perimeter bolts using a 3mm Allen wrench. Using lubrication and a 1/8" Allen wrench, install the included plug(s) to any of the 3 threaded holes.

-If installing 1 fuel pump, use 2 plugs.

-If installing 2 fuel pumps, use 1 plug (shown).

-If installing 3 fuel pumps, do NOT install any plugs.

Make sure the gasket is properly seated and reinstall all pieces excluding the fuel sensor mount.

NOTE: The 6-bolt flange cannot be improperly orientated as the bolt spacing is not symmetrical.



13. Cut the provided submersible fuel hose to the following sizes for each fuel pump.

Walbro GSS342 255LPH = 31mm long sections (shown)

AEM 50-1220 E85 = 41mm long sections (not shown)



14. Install the submersible hose onto each fuel pump outlet. Make sure the hose is fully seated all the way down on the fuel pump outlet barb. Slide 1 of the provided pinch clamps over each fuel pump submersible hose.

It is recommended to use pinch clamp pliers (shown in blue) to cinch the clamp(s). However, a standard pair of diagonal cutters (shown in red) can also be used.



15. Slide the provided screw-driven EFI clamp(s) over each fuel pump submersible hose.

One by one, install each fuel pump hose onto the short tubes on the underside of the triple pump block. Rotate each pump so the wire connectors are facing outwards. Make sure the clamp is positioned as high up the fuel hanger as possible. Apply a small amount of force onto the bottom of each fuel pump while tightening the corresponding clamp, as shown.

NOTE: If using less than 3 fuel pumps, ensure a fuel pump is not accidentally installed into a blocked off port.

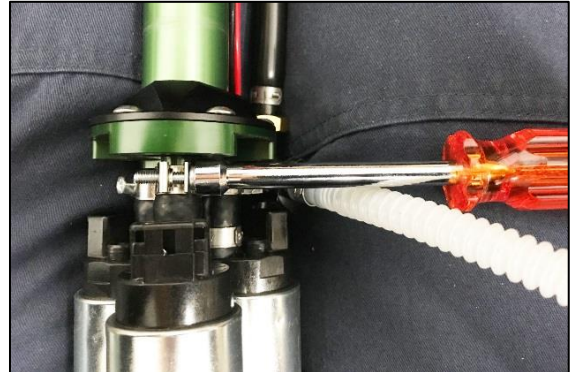

16. Before installing the top portion of the lower fuel pump filter screen, the fuel pump pinch clamp(s) may need to be slightly repositioned.

In order for the long M6 bolt to fit through this tight area, orient the pinch clamps similar to what is shown so there is clearance for the bolt.

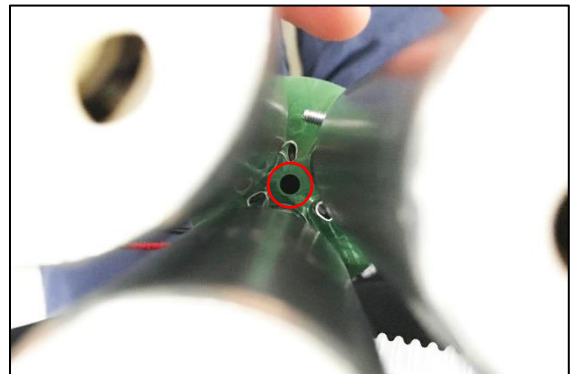

17. Follow below for installation of all suggested fuel pumps

To install the top portion of the lower fuel pump filter screen, the fuel pumps may need to be clocked to mate into the holes to line up (2 holes per pump). Once properly positioned, press towards the pump(s) until each is fully seated (see the following step's picture).

Find the long M6 bolt included in the kit. Insert through the center of the top portion of the lower fuel pump filter screen past the fuel pump(s). Apply a medium strength thread locker to the threaded end, as shown.



18. If installing 1 or 2 fuel pumps, screw in the bolt (shown red) with a 10mm socket wrench just enough before the filter assembly becomes crooked. Do NOT tighten! Use the included filter support bracket (shown blue) and the screws (shown yellow) to keep the assembly straight.

If installing 3 fuel pumps, the filter support bracket (shown blue) and lower screw (shown yellow) is NOT necessary. This is because the long bolt (shown red) can be fully tightened keeping everything symmetrical. Use a 10mm socket wrench.

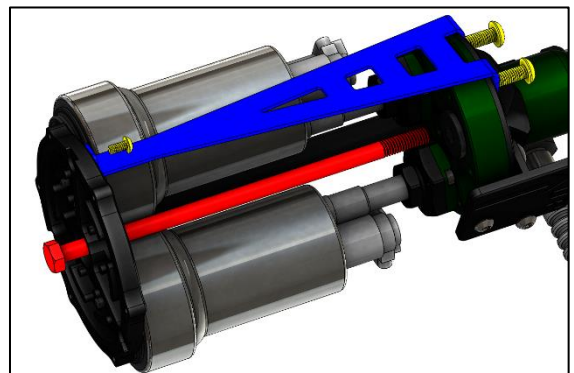

19. Make sure the mesh screen is preinstalled to the lower filter mount (green piece). If not, there are 3 tabs that the mesh screen simply slips into.

Place the lower filter mount onto the upper filter mount. Rotate so the 3 tabs lock in.

Using a 2mm Allen wrench, place the 6 provided screws through the lower filter mount and secure to the top portion of the filter screen, as shown. First, apply a medium-strength thread locker to each screw.



20. A Radium Engineering jet pump is included to help prevent fuel starvation.

Using an integrated venturi and incoming flow from the fuel pressure regulator return line, it mechanically draws in fuel from outside the sub-tank via the convoluted tubing. This outer fuel is then sent directly downwards to the fuel pump inlet(s). NOTE: In case there is no fuel outside the sub-tank to draw from, the jet pump does NOT produce unwanted air bubbles.

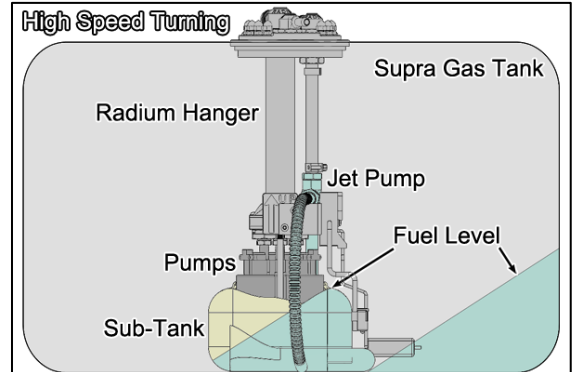

21. If using 1 or 2 fuel pumps or if sequentially staging 3 pumps, use a 2mm Allen wrench and install the jet pump retainer bracket to the top portion of the filter screen with the provided screw. To secure the jet pump return tube, insert the end into the retainer bracket, as shown. These 2 steps will already be done if the fuel hanger was purchased with fuel pumps included.

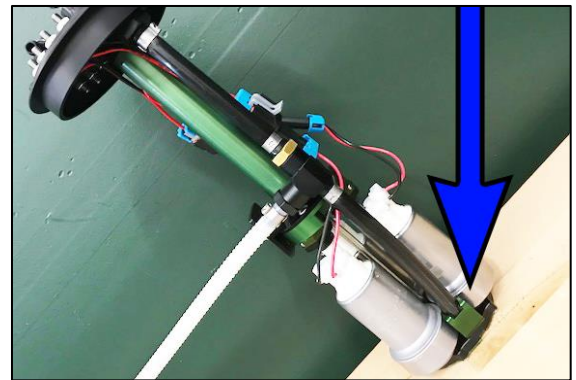

22. If there are plans to have ALL pumps running at the same time during low engine loads (low demand), excessive backpressure could potentially be present in the return. This will make low static fuel pressure hard to obtain. If this is true, remove the Radium venturi system and all 3 corresponding tubes. Follow the instructions below to revert back to mimic the OEM return.

For Twin Turbo 2JZ-GTE Supra running 2-3 pumps full time:

When installing the Radium hanger assembly into the gas tank (in later steps), reconnect the OEM internal rubber return hose in the gas tank to the return barb (underside of the fuel hat).

For non turbo 2JZ-GE Supra running 2-3 pumps full time:

As shown, attach the convoluted tubing to the upper return barb (clamp not included). Cut the convoluted tube to length allowing just enough length for securing into the retaining bracket.



23. If not installed already, secure the Radium fuel sensor mount to the rear-most area of the triple pump block. Two of the bolts from the triple pump block will first need to be removed with a 3mm Allen wrench. Referencing the picture at the right, note the "REAR" engraving on the fuel top hat and the 2 bolts on the "rear" of the triple pump block.

Using a 2.5mm Allen wrench, install the OEM fuel sensor bracket assembly to the Radium fuel sensor mount using the provided stainless steel button head bolts. Not shown here, but the convoluted "suction" tube from the jet pump will route in between the fuel sensor mount and the OEM fuel sensor bracket.

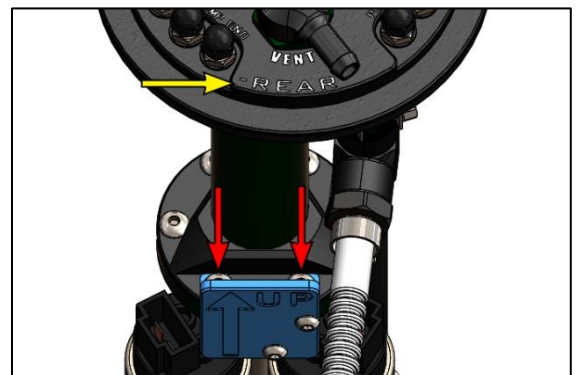

24. Find the 3 sensor wires hanging from the fuel hat. Match each wire color and push each terminal into the OEM 3-pin connector (see yellow arrow pictured).

RED WIRE Fuel Level Signal
BLACK WIRE Sensor Ground
BROWN WIRE Fuel Temperature Signal

Using the 2 cable zip-ties provided in the kit, neatly secure the fuel sensor and fuel pump wires to the long 10AN tube (see purple arrows pictured). As shown, a zip-tie can secure around the OEM fuel sensor connector and, if used, the Walbro F90000274 fuel pump connector(s).

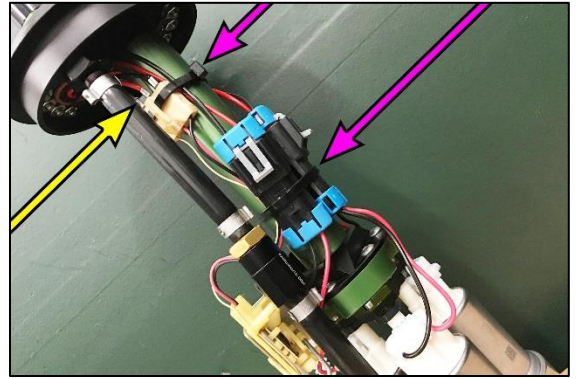

25. Find the OEM rubber gasket that was previously removed. Inspect to be sure there are no rips, tears, cuts, imperfections, etc.

Fully seat the gasket on the underside of the fuel hat, as shown.

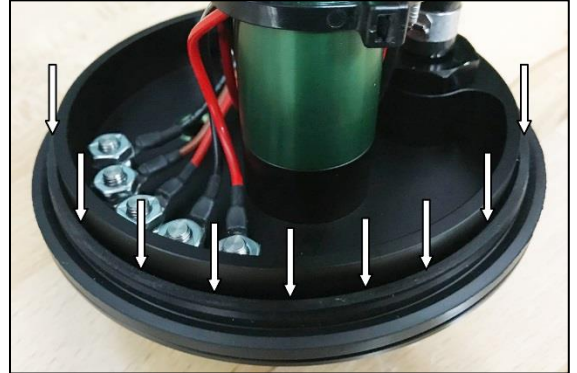

26. To install into the gas tank, the fuel level float must enter the gas tank first.

Carefully tip the fuel hanger assembly to angle in the fuel level float, as shown.



27. Next, insert the end of the loose convoluted tubing into the rear opening of the gas tank, as shown.



28. Next, use a 3mm Allen wrench to temporarily loosen the fuel sensor mount that attaches to the triple pump block. These are the vertically mounted screws from step 23. This will allow the fuel sensors to flex. Next, simultaneously push (or squeeze) the fuel temperature sensor inwards while pushing the fuel hanger assembly downwards into the gas tank, as depicted. Be careful not to damage the fuel sensors. Once the temperature sensor enters the tank, allow the sensor assembly to deflect back into position. Retighten the 2 Allen head screws.

Before lowering all the way down, first point the convoluted tubing downwards at the outside rear of the OEM sub-tank. This will keep the jet pump suction at the bottom of the OEM tank for optimal starvation protection.



29. Readjust vertically and slowly lower the fuel hanger assembly downwards.

Assuming the fuel hat "FRONT" and "REAR" markings are properly orientated, the assembly should auto-rotate into position once the fuel pump(s) reach the OEM sub tank.

Pictured is the fuel hanger assembly inside the gas tank when correctly installed.

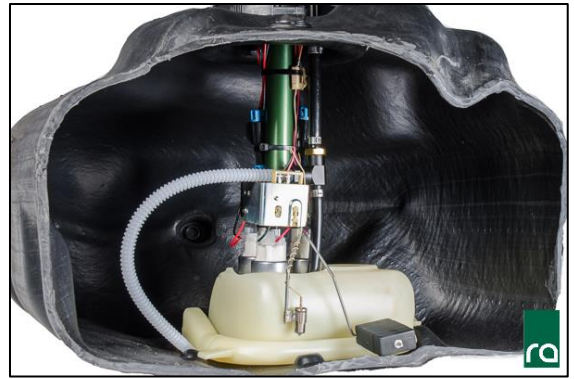

30. To reinstall the OEM black hold-down ring, rotate clockwise and tighten. NOTE: The top 3 fittings can freely swivel for additional space.

Reinstall the large worm drive jubilee clamp to lock the hold-down ring in place.



31. For plumbing and electrical access, the gas tank will need to be dropped down slightly.

First, safely raise the vehicle.

Carefully remove the 4 Phillips head screws on the bottom rear of the bumper cover. NOTE: because these are plastic, do not use a power tool as they can easily strip. Instead, use a manual screwdriver and refrain from applying any unnecessary force upwards while spinning counterclockwise.

After all 4 screws are removed, the black bar (shown) will pop down and out.



32. Using 10mm wrenches, remove the gas tank shield. This piece is held in by 6 bolts.



33. Using 10mm wrenches, remove the exhaust muffler shield. This piece is held in by 3 bolts.



34. Using a 14mm wrench, loosen the 4 bolts (shown) that secure the 2 gas tank mounting straps. Be careful to not remove the bolts as they only have 25mm of thread length. Allow the gas tank to drop down slightly.

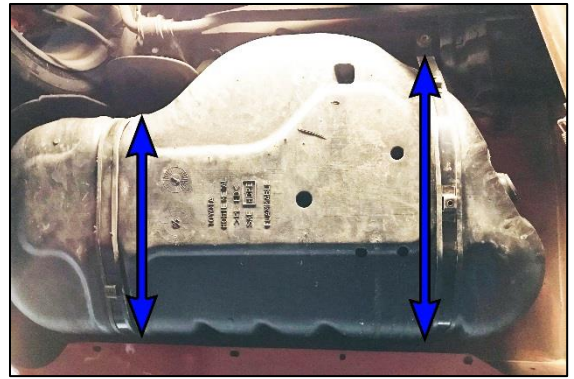

35. Find the gas tank wiring harness loom entering from the trunk floor grommet. Follow it towards the top of the fuel hanger.

Reach up to the front LH side of the gas tank and unlatch the wiring harness loom clip from the gas tank hole (shown). The wiring loom will still reside in the gas tank's sleeve holder. However, this will permit the 5 fuel hanger wires to move an extra inch or so for easier modifications in the following steps.



36. From above, dislodge the connector tabs and flip up. Cut all wires as close to the connector as possible. Remove some of the electrical tape and strip the wire insulation back 1/4", as shown.

- | | |
|--------------------------------------|--------------------------------|
| BROWN small gauge wire | Sensor Ground |
| YELLOW/BLUE small gauge wire | Fuel Temperature Signal |
| YELLOW/BLACK small gauge wire | Fuel Level Signal |
| BLUE large gauge wire | Fuel Pump Positive (+) |
| WHITE/BLACK large gauge wire | Fuel Pump Negative (-) |

Cut three 1/2" pieces of the small diameter shrink tube. Insert onto each sensor wire (3 small gauge wires). Next, crimp on a small gauge (AWG) ring terminal to each wire. Slide the shrink tube over the crimped section of the ring terminal and shrink into place with a heat gun.



37. **Single Pump Applications ONLY**

To reuse the OEM fuel pump power wiring, use the large diameter shrink tube and large gauge (AWG) ring terminals to connect the fuel pump wires.

NOTES:

1. In its OEM configuration, the Twin Turbo (2JZ-GTE) Supra uses 2 modes of fuel pump operation (high speed and low speed). Not discussed in this manual but this limitation can be bypassed to allow 12V to the fuel pump in all load conditions.
2. As shown, the Twin Turbo (2JZ-GTE) and Non-Turbo (2JZ-GE) Supras use the same Fuel Pump ECU and a 30A Fuse. However, the Twin Turbo (2JZ-GTE) Supra uses 2 EFI relays and the Non-Turbo (2JZ-GE) uses 1 EFI relay.

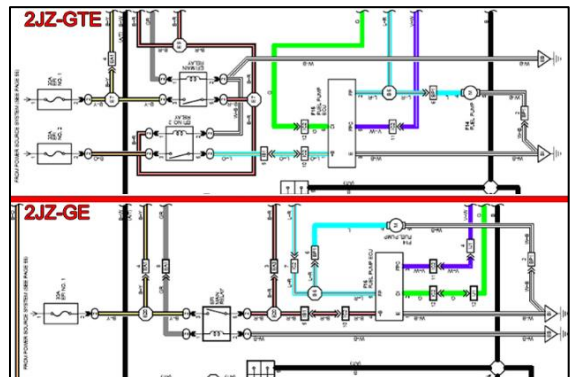

38. **Multi-Pump Applications**

Consider using Radium Engineering P/N: 17-0031 DIY Wiring Kit (shown) for each fuel pump. This includes a dedicated fuse, relay, 10AWG wire, etc. It is recommended to use the OEM fuel pump wiring to trigger this fused relay power source for each fuel pump.

WARNING: The OEM fuel pump wiring cannot supply power directly to multiple fuel pumps!

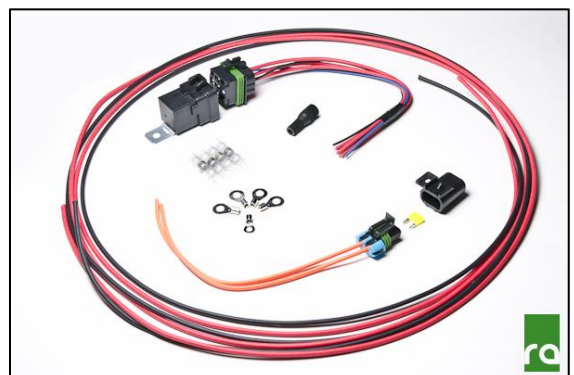

39. Using a 3/8" driver, secure all ring terminal connections to the electrical studs using the included acorn nuts. Do not overtighten and risk damaging the threads. These Nylon nuts provide insulation preventing an accidental short circuit.



40. If the OEM return hose will be reused, install the 2-piece barbed hose end to the return fitting. Push the OEM return hose onto the barb and secure with the OEM spring clamp, as shown. Connect the OEM vent hose to the provided barb fitting. Light oil lubrication may be required as this will be a tight fit. Secure the vent hose with the OEM spring clamp.

This kit requires aftermarket fuel feed hose for the provided low profile 8AN male feed fitting.

NOTE: the provided top hat fittings can be changed, if necessary. See port threads below.

- RADIUM Feed Port Threads 10AN ORB (7/8"-14)
- RADIUM Return Port Threads 8AN ORB (3/4"-16)
- RADIUM Vent Port Threads 6AN ORB (9/16"-18)



41. Reattach all fuel tank mounting related components in reverse order. Reconnect the battery using a 10mm wrench.

Turn the ignition key to the ON position to pressurize the fuel system. Confirm the new fuel pump(s) are properly operating. Check for leaks. If no leaks are found, start the vehicle.

NOTE: The engine may run rough for a few seconds until all air is bled from the fuel system.

Recheck for leaks.

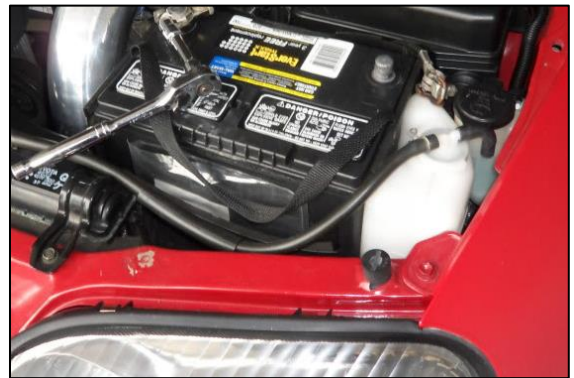

42. Before reinstalling the fuel tank access cover, new replacement foam is included to permit additional clearance for the upgraded fuel hose plumbing.

Remove the old original foam stuck to the bottom of the fuel tank access cover and clean it.



43. Find the adhesive foam included in the kit. Peel the backing off and apply on the flat areas around the cover on the inside of the 6 mounting holes (shown in blue). Cut to length.

Reinstall all components in reverse order.

FUEL HANGER INSTALLATION COMPLETE



44. Optional 20-0415-0X Fuel Hanger Plumbing Kits

Pop out the 10mm hex fastener that secures the hard line to soft line mount for the EVAP and return lines. Remove the plastic tubing carrier (shown) from the vehicle as it will not be reused.

NOTE: The fuel return line is closest towards the rear of the vehicle.

Unfasten the OEM spring clamp and pull the short rubber return line off the hard line, as shown. This will prevent a siphoning effect in later steps when fuel lines will be disconnected.



45. Safely lift and secure the vehicle. Find the fuel filter just left of the transmission.

When loosening the ends of the OEM fuel filter fittings, be prepared with a rag as fuel will leak out of these connections.

For the fuel filter inlet, use a 19mm wrench on the fuel filter hex and a 14mm flare nut wrench on the inverted flare fitting hex, as shown.

For the fuel filter outlet, use a 17mm socket breaker bar on the banjo bolt and a 19mm wrench on the fuel filter inlet hex.



46. Using a 10mm socket wrench, remove the ground wire ring terminal bolt. NOTE: This could be found on any one of the 3 bolts shown.

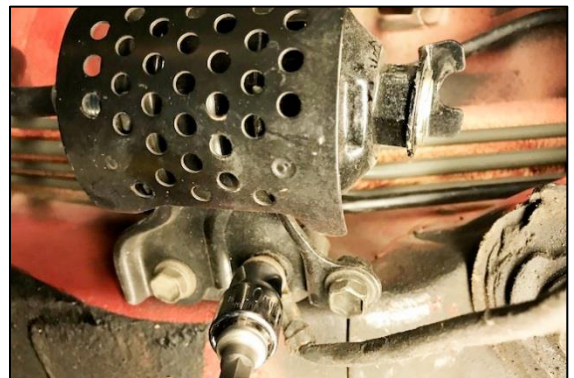

47. Using a 10mm socket wrench, remove the 2 bolts that secure the fuel filter to the fuel filter mount.



48. Using a 10mm socket wrench, remove the 2 bolts that secure the fuel filter mount to the chassis.

The fuel filter, fuel filter fittings, fuel filter mount, and mounting bolts will NOT be reused.

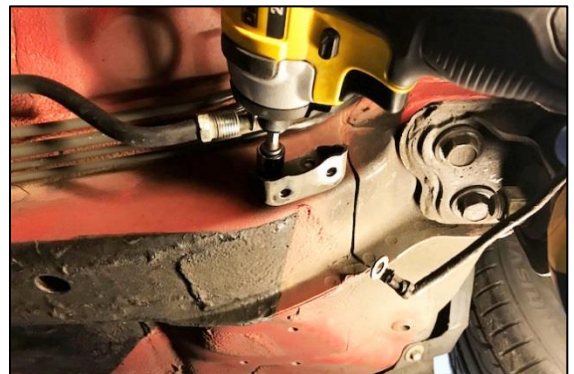

49. From the engine bay, remove the fuel rail feed line banjo bolt.

Using a 10mm wrench, remove the M6 bolt that secures the fuel feed line to the intake manifold.

Using a 12mm wrench, remove the 2 bolts that secure the fuel pulsation damper housing to the engine block.

In one piece, pull the fuel feed line out of the vehicle. This will include everything from the fuel filter outlet banjo to the fuel rail inlet, as shown.



50. Remove the 6 fasteners that hold the plastic hard line covers.

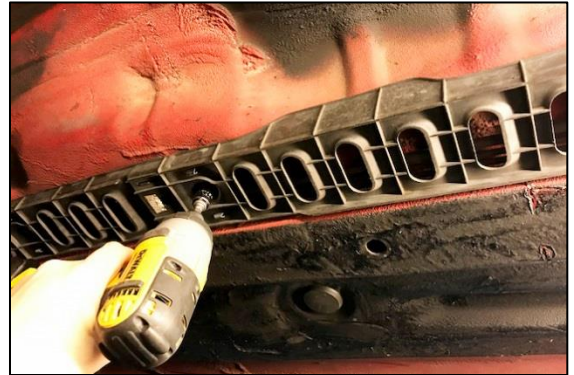

51. Pry the locking tabs to release the plastic hard line covers.



52. One by one, lower the plastic hard line covers.

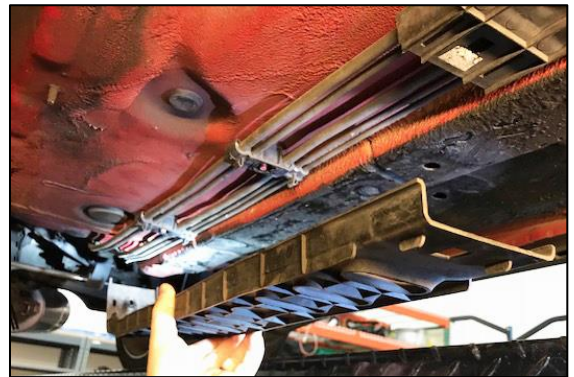

53. Using a 10mm socket wrench, remove the last plastic cover that is located to the left rear of the differential near the muffler.

The 3 plastic covers are shown. These will not be reused.



54. Carefully pry and pop off all the hard line retainers, as shown.



55. In one piece, pull the fuel feed line out of the vehicle. This will include everything from the fuel pump hanger banjo soft line to the fuel filter inlet inverted flare hard line, as shown.

NOTE: This can be reinstalled if the vehicle ever needs to be put back to factory specifications.

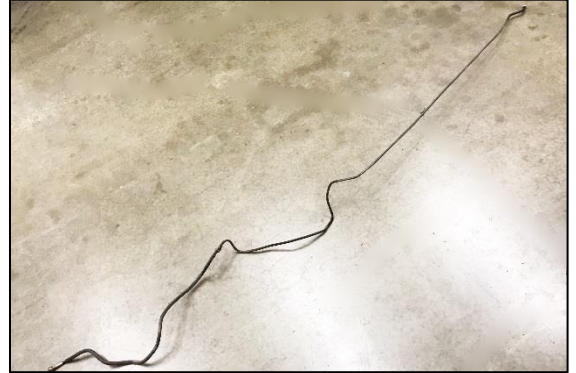

56. From the engine bay, unscrew the fuel rail return line banjo bolt (shown) from the fuel pressure regulator.

Using a 10mm wrench, remove the M6 bolt that secures the return line to the intake manifold.

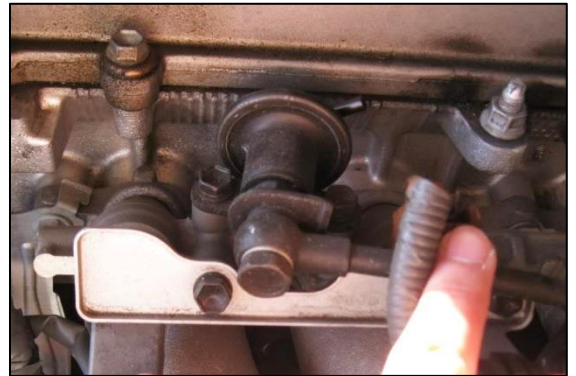

57. **NOTE: The long OEM return hard line does not HAVE TO be removed from the vehicle.**

This step is optional for those that have no plans to reuse the OEM return line. The OEM return line can be reinstalled if necessary.

This step is easiest with two people. First, safely drop the gas tank down slightly to pull the return hard line out of the fuel hanger trunk space area. Pull the fuel return line forward and around the suspension, half shafts, etc. (if installed).

In one piece, pull the fuel return line out of the vehicle. This will include everything from the fuel pressure regulator banjo to the fuel hanger return hard line, as shown.



58. Using a 5mm Allen hex wrench, install the lower half of the Radium fuel filter mount to the unibody in the former location of the OEM fuel filter using the provided M6 socket head bolts, as shown.



59. The filter has markings identifying the "INLET" and the "OUTLET". Using a 1" wrench, install the 10AN ORB to 8AN male fitting to the fuel filter inlet and the 10AN ORB to 10AN male fitting to the fuel filter outlet.

NOTES:

1. Oil lubrication must first be applied to the O-rings to prevent damage.
2. Aluminum wrenches can help prevent marring of the anodized hex finish.



60. Place the fuel filter on the lower half mount with the outlet facing the engine bay and the inlet facing the rear of the vehicle.

Using a 4mm Allen hex wrench, install the upper half of the fuel filter mount using the provided M5 socket head bolts, as shown. Do not fully torque these bolts yet as the filter will be repositioned later.



61. Using a 10mm socket wrench, remove the M6 bolt that secures the brake line adapter junction point shown.



62. Relocate and secure the electrical ground wire ring terminal to the mounting boss, as shown.

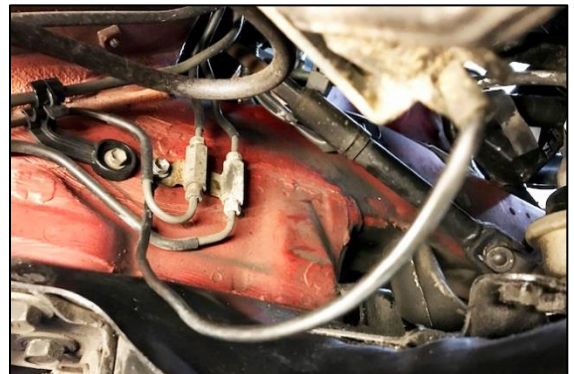

63. NOTE: for this plumbing kit to connect properly, the fuel rail (not included) must have an 8AN ORB threaded front port. Radium Engineering recommends, 2JZ-GTE Fuel Rail P/N: 20-0215. Install the included 8AN ORB to 10AN male fitting to the front port of the fuel rail.

Connect the -10AN hose to the front port of the fuel rail and route the hose back and down to the fuel filter outlet. **Stay clear of the steering shaft.** Loosely install these two hose end fitting connections.

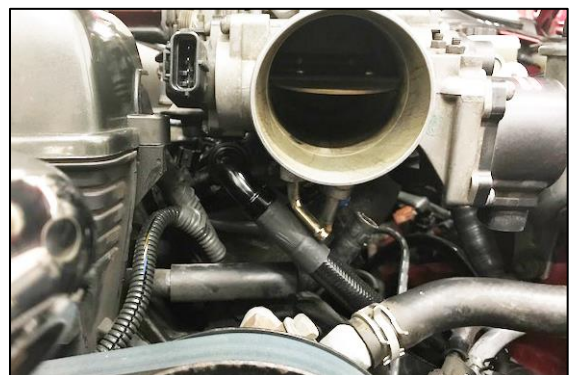

64. Notice there are a few different types of hard line retainers in the MKIV Toyota Supra. Some are shorter than others. For instance, the JZA80 chassis has raised M6 nuts in some locations.

Reinstall all OEM hard line retainers excluding the 4 at the middle of the car at the straight section.



65. Safely, loosen the gas tank straps to lower the tank down slightly as outlined in earlier steps.

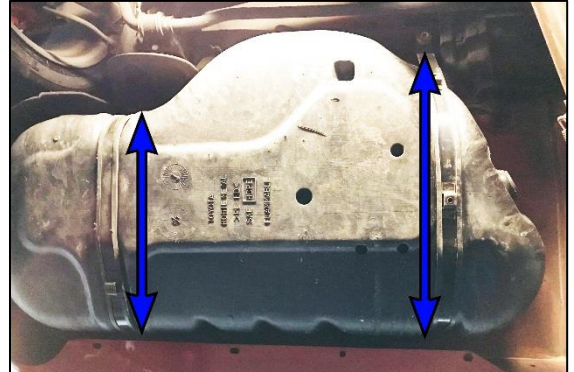

66. The new fuel lines will be routed in the same manner as the OEM fuel lines.

From the trunk, slide the long 8AN feed line down the front LH side opening. Next, slide the 90 degree hose end of the long 6AN return line down the front LH side opening. Route the 6AN return line to the RH side of the 8AN feed line during the entire run, as depicted.

Loosely install the 8AN feed line onto the fuel filter inlet and fuel pump hanger outlet fitting. Do not secure this fuel line to the unibody yet.

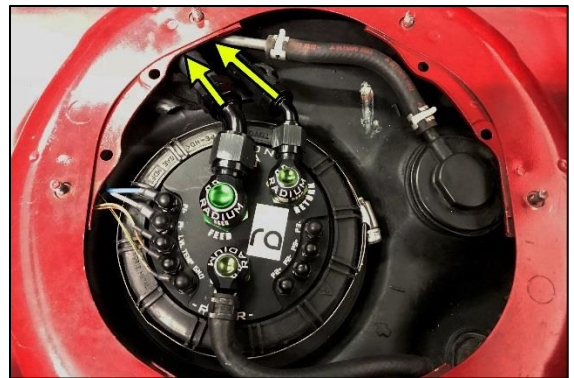

67. For this plumbing kit to connect properly, the fuel pressure regulator (not included) must have a 6AN male return port. Radium Engineering recommends, DMR P/N: 20-0223-0X which can connect directly to the rear port of the Radium fuel rail, as shown.

Install the return line to the 6AN fuel pressure regulator return fitting. Loosely install this connection and the connection at the fuel hanger.

NOTE: Depending on the fuel pressure regulator used and where it is located, this return hose may need to be extended.



68. Secure the return line near the fuel filter using one of the provided cable zip ties, as shown.



69. Using the OEM hardware and a 10mm socket wrench, install the 4 Radium retainers.

If the OEM return line was removed, this slot will be empty, as shown. Alternatively, this slot can be used to run the fuel pump relay power wire(s) up to the battery, if necessary.



70. Just in front of the LH half shaft, the OEM hard lines make tight bends. For optimal fuel flow, the replacement PTFE fuel lines will bypass this potential restriction.

Find the OEM stud shown. Using the provided M6x1mm nut and 2 cushioned P-clamps, secure the feed and return lines to the stud with a 10mm socket wrench.



71. Using the provided cable zip ties, secure the return line to the retainers, as shown.



72. NOTE: the rearmost retainer will not require zip ties as the retainer touches the floorboard.

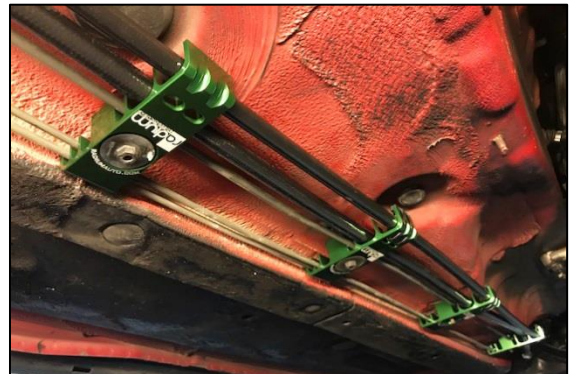

73. After tightening all related fittings, secure the fuel filter clamp using a 4mm Allen hex wrench. Notice how the filter is slide upwards inside the clamp to add ground clearance.



74. Reinstall all components in reverse order.

Make sure the fuel lines near the gas tank have adequate clearance and is not chaffing on any nearby parts.

FUEL PLUMBING KIT INSTALLATION COMPLETE



75. NOTE: A gauge or pressure transducer sensor will need to be implemented in the system for adjusting fuel pressure. If using a Radium Engineering 2JZ-GTE top-feed injector fuel rail (part number 20-0215) and a factory OEM intake manifold, follow the steps below for installing a pressure gauge in the rear-most bottom port of the Radium fuel rail. If using an aftermarket intake manifold, this procedure and selection of parts may be different.

Parts Needed:

(x1) 20-0029 Fuel Pressure Gauge

(x1) 14-0119 8AN ORB to 1/8NPT Female Fitting

(x2) 14-0332 1/8NPT Male to Female, 90Deg Elbow



76. Install the 14-0119 into the rear most bottom port of the fuel rail as shown. Lubricate the O-ring with oil and tighten.



77. Apply a conservative amount of PTFE paste to the male threads of one of the 14-0332 1/8 NPT elbows and screw it into the 14-0119 adapter.



78. NPT threaded fittings should first be tightened finger tight. Then, using a wrench, add another 1.5 to 3 turns until fully tight and pointing straight up (same direction as the injector electrical connections).



79. Using the same PTFE paste and tightening procedure as the first 1/8NPT elbow, install the second elbow into the outlet of the first elbow, as shown.



80. When the tightening is complete, the second elbow fitting should be pointing at approximately 45 degrees to the fuel rail, as depicted.



81. Apply a small amount of PTFE paste to the pressure gauge threads and install into the elbow fitting, as shown. Use a 7/16" wrench to tighten the gauge and a second wrench to hold the elbow fitting.

Test fit the fuel rail to the intake manifold. Temporarily install the OEM intake plenum and check for clearance with the gauge. If necessary, slightly adjust the gauge until it clears the intake plenum and cylinder head.

